

OVERVIEW

The SM8707 series are dual-PLL clock generator ICs, using a 27MHz master clock, that generate independent audio clock, video clock, and signal processor clock outputs needed in DVD player/recorder applications. Each PLL loop filter and crystal oscillator circuit are built-in and require no external components, resulting in high-precision clocks. The lineup includes devices that support both 44.1/48kHz audio sampling frequencies (fs), switchable using a control pin. The sampling frequency can be switched during operation without generating any output spike noise.

FEATURES

- Supply voltage: 3.0 to 3.6V
- Low current consumption: 35mA typ.
($V_{DD} = 3.3V$, all outputs with no load)
- 27MHz master clock
(internal PLL reference clock)
- Generated clocks (Refer to “Output Frequency Listing” on page 18 for details.)
- PLL loop filter built-in
- Crystal oscillator circuit built-in
- Sampling frequency fs: 44.1/48kHz
- 16-pin VSOP package (Pb free)

	SM8707D	SM8707E	SM8707F	SM8707G	SM8707H	SM8707J
Video system output	27.0000MHz	27.0000MHz	27.0000MHz	27.0000MHz	27.0000MHz	—
Audio system output	512fs 768fs ¹ 384fs ¹	512fs	768fs	—	512fs	768fs
Signal processor system output	16.9344MHz 33.8688MHz	33.8688MHz	16.9344MHz 33.8688MHz	33.8688MHz	16.9344MHz 33.8688MHz 36.8640MHz	18.4320MHz 24.5760MHz 33.8688MHz 36.8640MHz

1. 384fs (fs = 44.1kHz)/768fs (fs = 48kHz)

- Low jitter output (1-sigma output load capacitance typical values)

	SM8707D	SM8707E	SM8707F	SM8707G	SM8707H	SM8707J
Video system output	20ps	20ps	20ps	20ps	20ps	—
Audio and Signal processor system output	70ps	55ps	40ps	40ps	70ps	60ps

APPLICATIONS

- DVD players
- DVD car navigation system

ORDERING INFORMATION

Device	Package
SM8707DV	16-pin VSOP
SM8707EV	
SM8707FV	
SM8707GV	
SM8707HV	
SM8707JV	

PACKAGE DIMENSIONS

(Unit: mm)

Weight: 0.07g

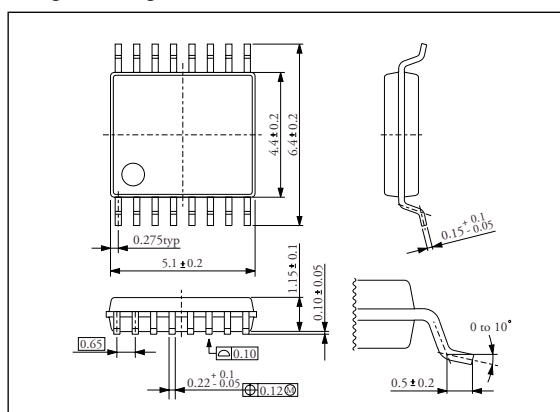

PINOUT

(Top view)

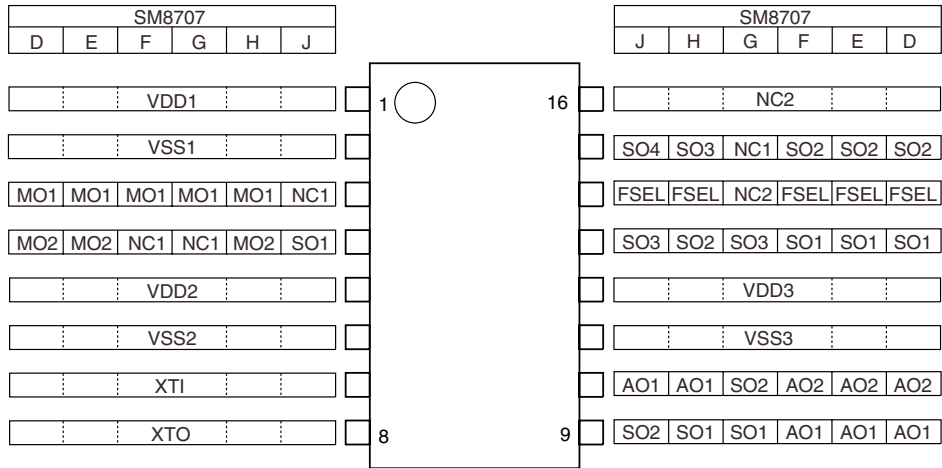

PIN DESCRIPTION

Name	I/O	Description
MO _x	O	Video system output
AO _x	O	Audio system output
SO _x	O	Signal processor system output
FSEL	I	Sampling frequency select
XTI	I	Crystal oscillator connection or external clock input
XTO	O	Crystal oscillator connection
VDD1	-	Supply for digital block
VSS1	-	Ground for digital block
VDD2	-	Supply for analog block
VSS2	-	Ground for analog block
VDD3	-	Supply for digital block
VSS3	-	Ground for digital block
NC1	O	No connection output (leave pin open circuit)
NC2	I	No connection (leave pin open circuit or connect to VDD)

BLOCK DIAGRAM

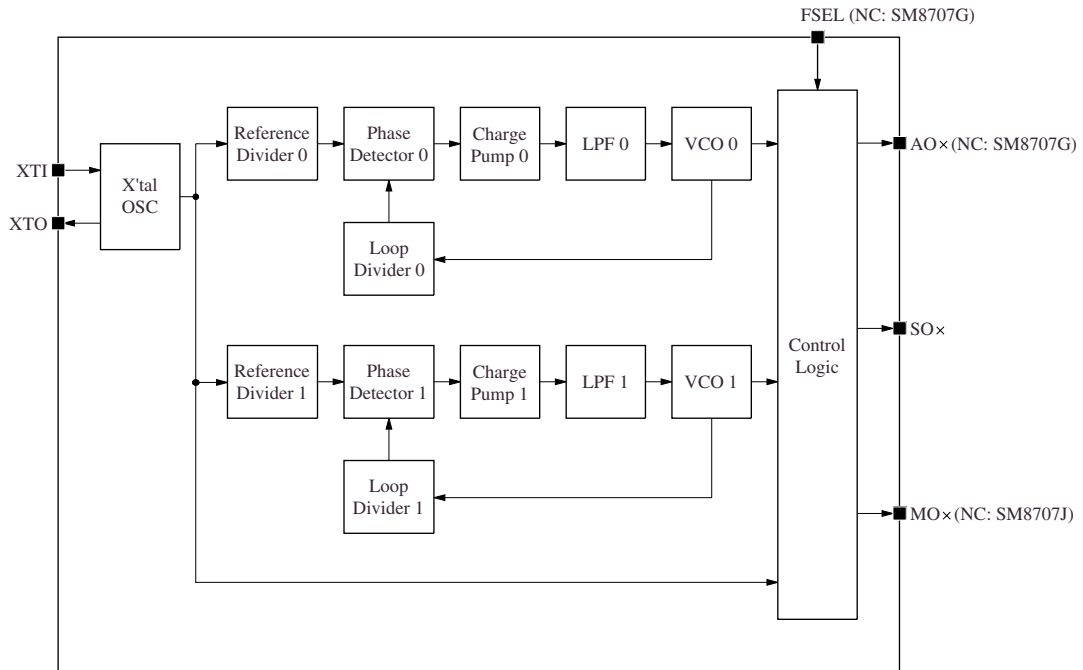

SM8707 series

Note: Unless otherwise noted, VDD applies to VDD1, VDD2, and VDD3. Similarly, VSS applies to VSS1, VSS2, and VSS3.

SPECIFICATIONS

Absolute Maximum Ratings

Parameter	Symbol	Condition	Rating	Unit
Supply voltage range	$V_{DD1}, V_{DD2}, V_{DD3}$		- 0.3 to + 6.5	V
Supply voltage deviation	$V_{DD1} - V_{DD2},$ $V_{DD1} - V_{DD3},$ $V_{DD2} - V_{DD3}$		± 0.1	V
Input voltage range	V_{IN}		- 0.3 to $V_{DD} + 0.3$	V
Output voltage range	V_{OUT}		- 0.3 to $V_{DD} + 0.3$	V
Power dissipation	P_D		165	mW
Storage temperature range	T_{stg}		- 55 to + 125	°C

Recommended Operating Conditions

$V_{SS} = V_{SS1} = V_{SS2} = V_{SS3} = 0V$ unless otherwise noted.

Note 1: The supply voltage is defined relative to $V_{SS} = 0V$.

Note 2: The supply voltages applied on VDD1, VDD2, and VDD3 should be derived from a common supply source.

Note 3: If the supply voltages on VDD1, VDD2, and VDD3 are from different sources, they should be applied simultaneously. The SM8707 may be damaged if the supply voltage timing is different.

SM8707D

Parameter	Symbol	Condition	Rating			Unit
			min	typ	max	
Supply voltage ranges	$V_{DD1}, V_{DD2}, V_{DD3}$	(Note 1, 2, 3)	+ 3.0	-	+ 3.6	V
Output load capacitance 1	C_{L1}	MO1, MO2, SO1, SO2 outputs	-	-	25	pF
Output load capacitance 2	C_{L2}	AO1, AO2 outputs	-	-	15	pF
Master clock frequency	f_{XTAL}	When using crystal oscillator	-	27.0000	-	MHz
Operating temperature range	T_{opr}		- 40	-	+ 85	°C

SM8707E

Parameter	Symbol	Condition	Rating			Unit
			min	typ	max	
Supply voltage ranges	$V_{DD1}, V_{DD2}, V_{DD3}$	(Note 1, 2, 3)	+ 3.0	-	+ 3.6	V
Output load capacitance 1	C_{L1}	MO1 output	-	-	40	pF
Output load capacitance 2	C_{L2}	MO2 output	-	-	25	pF
Output load capacitance 3	C_{L3}	SO1, SO2, AO1, AO2 outputs	-	-	15	pF
Master clock frequency	f_{XTAL}	When using crystal oscillator	-	27.0000	-	MHz
Operating temperature range	T_{opr}		- 10	-	+ 75	°C

SM8707 series

SM8707F

Parameter	Symbol	Condition	Rating			Unit
			min	typ	max	
Supply voltage ranges	$V_{DD1}, V_{DD2}, V_{DD3}$	(Note 1, 2, 3)	+ 3.0	–	+ 3.6	V
Output load capacitance 1	C_{L1}	MO1, SO1, SO2 outputs	–	–	25	pF
Output load capacitance 2	C_{L2}	AO1, AO2 outputs	–	–	15	pF
Master clock frequency	f_{XTAL}	When using crystal oscillator	–	27.0000	–	MHz
Operating temperature range	T_{opr}		– 40	–	+ 85	°C

SM8707G

Parameter	Symbol	Condition	Rating			Unit
			min	typ	max	
Supply voltage ranges	$V_{DD1}, V_{DD2}, V_{DD3}$	(Note 1, 2, 3)	+ 3.0	–	+ 3.6	V
Output load capacitance 1	C_{L1}	MO1 output	–	–	40	pF
Output load capacitance 2	C_{L2}	SO3 output	–	–	25	pF
Output load capacitance 3	C_{L3}	SO1, SO2 outputs	–	–	15	pF
Master clock frequency	f_{XTAL}	When using crystal oscillator	–	27.0000	–	MHz
Operating temperature range	T_{opr}		– 10	–	+ 75	°C

SM8707H

Parameter	Symbol	Condition	Rating			Unit
			min	typ	max	
Supply voltage ranges	$V_{DD1}, V_{DD2}, V_{DD3}$	(Note 1, 2, 3)	+ 3.0	–	+ 3.6	V
Output load capacitance 1	C_{L1}	MO1, MO2, SO2, SO3 outputs	–	–	25	pF
Output load capacitance 2	C_{L2}	AO1, SO1 outputs	–	–	15	pF
Master clock frequency	f_{XTAL}	When using crystal oscillator	–	27.0000	–	MHz
Operating temperature range	T_{opr}		– 40	–	+ 85	°C

SM8707J

Parameter	Symbol	Condition	Rating			Unit
			min	typ	max	
Supply voltage ranges	$V_{DD1}, V_{DD2}, V_{DD3}$	(Note 1, 2, 3)	+ 3.0	–	+ 3.6	V
Output load capacitance	C_L	Outputs	–	–	25	pF
Master clock frequency	f_{XTAL}	When using crystal oscillator	–	27.0000	–	MHz
Operating temperature range	T_{opr}		– 40	–	+ 85	°C

DC Electrical Characteristics

- SM8707D/F/H/J
 $f_{XTAL} = 27.0000\text{MHz}$, $V_{DD} = 3.3\text{V} \pm 0.3\text{V}$, $V_{SS} = 0\text{V}$, $T_a = -40$ to $+85$ °C unless otherwise noted.
- SM8707E/G
 $f_{XTAL} = 27.0000\text{MHz}$, $V_{DD} = 3.3\text{V} \pm 0.3\text{V}$, $V_{SS} = 0\text{V}$, $T_a = -10$ to $+75$ °C unless otherwise noted.

Parameter	Symbol	Pins	Condition	Rating			Unit	
				min	typ	max		
Current consumption	I_{DD}	VDD	$V_{DD} = 3.3\text{V}$, $T_a = 25^\circ\text{C}$, $f_s = 48\text{kHz}$, Crystal oscillator connected, no load on all outputs	Excluding SM8707G	–	35	45	mA
				SM8707G	–	20	27	
Input voltage	V_{IH}	FSEL, XTI	$V_{DD} = 3.3\text{V}$		$0.8 V_{DD}$	–	–	V
	V_{IL}				–	–	$0.2 V_{DD}$	
Input current	I_{IH1}	FSEL ¹	$V_{IN} = V_{DD}$		–	–	1	μA
	I_{IL1}		$V_{IN} = 0\text{V}$		–100	–	–	
	I_{IH2}	XTI	$V_{IN} = V_{DD}$		–	–	40	
	I_{IL2}		$V_{IN} = 0\text{V}$		–40	–	–	
Output voltage	V_{OH}	All outputs excluding XTO	$I_{OH} = -2\text{mA}$		$V_{DD} - 0.4$	–	–	V
	V_{OL}		$I_{OL} = 2\text{mA}$		–	–	0.4	

1. FSEL pin has Schmitt-trigger input and built-in pull-up resistor (SM8707G: NC pin).

AC Electrical Characteristics

SM8707D

$f_{XTAL} = 27.0000\text{MHz}$, $V_{DD} = 3.3\text{V} \pm 0.3\text{V}$, $V_{SS} = 0\text{V}$, $T_a = -40$ to $+85$ °C unless otherwise noted.

Parameter	Symbol	Pins	Condition	Rating			Unit
				min	typ	max	
External input clock frequency ¹	f_{XTI}	XTI	Applies to external clock input use only	–	27.0000	–	MHz
Output clock rise time ²	t_r	MO1, MO2, SO1, SO2	$C_L = 25$ pF, transition between $V_{OL} = 0.2V_{DD}$ and $V_{OH} = 0.8V_{DD}$	–	2.0	–	ns
		AO1, AO2	$C_L = 15$ pF, transition between $V_{OL} = 0.2V_{DD}$ and $V_{OH} = 0.8V_{DD}$	–	2.0	–	
Output clock fall time ²	t_f	MO1, MO2, SO1, SO2	$C_L = 25$ pF, transition between $V_{OH} = 0.8V_{DD}$ and $V_{OL} = 0.2V_{DD}$	–	2.0	–	ns
		AO1, AO2	$C_L = 15$ pF, transition between $V_{OH} = 0.8V_{DD}$ and $V_{OL} = 0.2V_{DD}$	–	2.0	–	
Output clock jitter ³	$t_{\text{jitter}}^{\dagger}$ (1-sigma)	MO1, MO2	$T_a = 25^\circ\text{C}$, $C_L = 25$ pF, $V_O = 0.5V_{DD}$	–	20	–	ps
		SO1, SO2		–	70	–	
		AO1, AO2	$T_a = 25^\circ\text{C}$, $C_L = 15$ pF, $V_O = 0.5V_{DD}$	–	70	–	
Output clock duty cycle ²	Dt	MO1, MO2, SO1, SO2	$T_a = 25^\circ\text{C}$, $C_L = 25$ pF, $V_O = 0.5V_{DD}$	45	50	55	%
		AO1, AO2	$T_a = 25^\circ\text{C}$, $C_L = 15$ pF, $V_O = 0.5V_{DD}$	45	50	55	
Settling time ²	t_s	All outputs excluding XTO		–	–	1	μs
Power-up time ^{2, 4}	t_p	All outputs excluding XTO		–	1	5	ms

1. When using an external clock input, the XTI duty should be 50% with 3.3V clock signal amplitude level. The input signal voltage should not exceed the absolute maximum rating, otherwise damage may occur.
2. The numeric values are measured values obtained using the circuit in Figure 1 and the NPC standard evaluation board.
3. The numeric values are measured values obtained using the circuit in Figure 2 and the NPC standard evaluation board.
4. This is the time, after the supply is turned ON from the OFF state, until the output clock reaches $\pm 0.1\%$ of the specified frequency.

SM8707 series

SM8707E

$f_{XTAL} = 27.0000\text{MHz}$, $V_{DD} = 3.3\text{V} \pm 0.3\text{V}$, $V_{SS} = 0\text{V}$, $T_a = -10$ to $+75\text{ }^\circ\text{C}$ unless otherwise noted.

Parameter	Symbol	Pins	Condition	Rating			Unit
				min	typ	max	
External input clock frequency ¹	f_{XTI}	XTI	Applies to external clock input use only	–	27.0000	–	MHz
Output clock rise time ²	t_r	MO1	$C_L = 40\text{ pF}$, transition between $V_{OL} = 0.2V_{DD}$ and $V_{OH} = 0.8V_{DD}$	–	2.0	–	ns
		MO2	$C_L = 25\text{ pF}$, transition between $V_{OL} = 0.2V_{DD}$ and $V_{OH} = 0.8V_{DD}$	–	2.0	–	
		SO1, SO2, AO1, AO2	$C_L = 15\text{ pF}$, transition between $V_{OL} = 0.2V_{DD}$ and $V_{OH} = 0.8V_{DD}$	–	2.0	–	
Output clock fall time ²	t_f	MO1	$C_L = 40\text{ pF}$, transition between $V_{OH} = 0.8V_{DD}$ and $V_{OL} = 0.2V_{DD}$	–	2.0	–	ns
		MO2	$C_L = 25\text{ pF}$, transition between $V_{OH} = 0.8V_{DD}$ and $V_{OL} = 0.2V_{DD}$	–	2.0	–	
		SO1, SO2, AO1, AO2	$C_L = 15\text{ pF}$, transition between $V_{OH} = 0.8V_{DD}$ and $V_{OL} = 0.2V_{DD}$	–	2.0	–	
Output clock jitter ³	$t_{\text{jitter}} (1\text{-sigma})$	MO1	$T_a = 25^\circ\text{C}$, $C_L = 40\text{ pF}$, $V_O = 0.5V_{DD}$	–	20	–	ps
		MO2	$T_a = 25^\circ\text{C}$, $C_L = 25\text{ pF}$, $V_O = 0.5V_{DD}$	–	20	–	
		SO1, SO2, AO1, AO2	$T_a = 25^\circ\text{C}$, $C_L = 15\text{ pF}$, $V_O = 0.5V_{DD}$	–	55	–	
Output clock duty cycle ²	Dt	MO1	$T_a = 25^\circ\text{C}$, $C_L = 40\text{ pF}$, $V_O = 0.5V_{DD}$	45	50	55	%
		MO2	$T_a = 25^\circ\text{C}$, $C_L = 25\text{ pF}$, $V_O = 0.5V_{DD}$	45	50	55	
		SO1, SO2, AO1, AO2	$T_a = 25^\circ\text{C}$, $C_L = 15\text{ pF}$, $V_O = 0.5V_{DD}$	45	50	55	
Settling time ²	t_s	AO1, AO2		–	–	1	μs
Power-up time ^{2, 4}	t_p	All outputs excluding XTO		–	1	5	ms

1. When using an external clock input, the XTI duty should be 50% with 3.3V clock signal amplitude level. The input signal voltage should not exceed the absolute maximum rating, otherwise damage may occur.
2. The numeric values are measured values obtained using the circuit in Figure 1 and the NPC standard evaluation board.
3. The numeric values are measured values obtained using the circuit in Figure 2 and the NPC standard evaluation board.
4. This is the time, after the supply is turned ON from the OFF state, until the output clock reaches $\pm 0.1\%$ of the specified frequency.

SM8707 series

SM8707F

$f_{XTAL} = 27.0000\text{MHz}$, $V_{DD} = 3.3\text{V} \pm 0.3\text{V}$, $V_{SS} = 0\text{V}$, $T_a = -40$ to $+85$ °C unless otherwise noted.

Parameter	Symbol	Pins	Condition	Rating			Unit
				min	typ	max	
External input clock frequency ¹	f_{XTI}	XTI	Applies to external clock input use only	–	27.0000	–	MHz
Output clock rise time ²	t_r	MO1, SO1, SO2	$C_L = 25$ pF, transition between $V_{OL} = 0.2V_{DD}$ and $V_{OH} = 0.8V_{DD}$	–	2.0	–	ns
		AO1, AO2	$C_L = 15$ pF, transition between $V_{OL} = 0.2V_{DD}$ and $V_{OH} = 0.8V_{DD}$	–	2.0	–	
Output clock fall time ²	t_f	MO1, SO1, SO2	$C_L = 25$ pF, transition between $V_{OH} = 0.8V_{DD}$ and $V_{OL} = 0.2V_{DD}$	–	2.0	–	ns
		AO1, AO2	$C_L = 15$ pF, transition between $V_{OH} = 0.8V_{DD}$ and $V_{OL} = 0.2V_{DD}$	–	2.0	–	
Output clock jitter ³	t_{jitter} (1-sigma)	MO1	$T_a = 25^\circ\text{C}$, $C_L = 25$ pF, $V_O = 0.5V_{DD}$	–	20	–	ps
		SO1, SO2		–	40	–	
		AO1, AO2	$T_a = 25^\circ\text{C}$, $C_L = 15$ pF, $V_O = 0.5V_{DD}$	–	40	–	
Output clock duty cycle ²	Dt	MO1, SO1, SO2	$T_a = 25^\circ\text{C}$, $C_L = 25$ pF, $V_O = 0.5V_{DD}$	45	50	55	%
		AO1, AO2	$T_a = 25^\circ\text{C}$, $C_L = 15$ pF, $V_O = 0.5V_{DD}$	45	50	55	
Settling time ²	t_s	All outputs excluding XTO		–	–	1	μs
Power-up time ^{2, 4}	t_p	All outputs excluding XTO		–	1	5	ms

1. When using an external clock input, the XTI duty should be 50% with 3.3V clock signal amplitude level. The input signal voltage should not exceed the absolute maximum rating, otherwise damage may occur.
2. The numeric values are measured values obtained using the circuit in Figure 1 and the NPC standard evaluation board.
3. The numeric values are measured values obtained using the circuit in Figure 2 and the NPC standard evaluation board.
4. This is the time, after the supply is turned ON from the OFF state, until the output clock reaches $\pm 0.1\%$ of the specified frequency.

SM8707 series

SM8707G

$f_{XTAL} = 27.0000\text{MHz}$, $V_{DD} = 3.3\text{V} \pm 0.3\text{V}$, $V_{SS} = 0\text{V}$, $T_a = -10$ to $+75\text{ }^\circ\text{C}$ unless otherwise noted.

Parameter	Symbol	Pins	Condition	Rating			Unit
				min	typ	max	
External input clock frequency ¹	f_{XTI}	XTI	Applies to external clock input use only	–	27.0000	–	MHz
Output clock rise time ²	t_r	MO1	$C_L = 40\text{ pF}$, transition between $V_{OL} = 0.2V_{DD}$ and $V_{OH} = 0.8V_{DD}$	–	2.0	–	ns
		SO3	$C_L = 25\text{ pF}$, transition between $V_{OL} = 0.2V_{DD}$ and $V_{OH} = 0.8V_{DD}$	–	2.0	–	
		SO1, SO2	$C_L = 15\text{ pF}$, transition between $V_{OL} = 0.2V_{DD}$ and $V_{OH} = 0.8V_{DD}$	–	2.0	–	
Output clock fall time ²	t_f	MO1	$C_L = 40\text{ pF}$, transition between $V_{OH} = 0.8V_{DD}$ and $V_{OL} = 0.2V_{DD}$	–	2.0	–	ns
		SO3	$C_L = 25\text{ pF}$, transition between $V_{OH} = 0.8V_{DD}$ and $V_{OL} = 0.2V_{DD}$	–	2.0	–	
		SO1, SO2	$C_L = 15\text{ pF}$, transition between $V_{OH} = 0.8V_{DD}$ and $V_{OL} = 0.2V_{DD}$	–	2.0	–	
Output clock jitter ³	$t_{\text{jitter}}^{(1-\text{sigma})}$	MO1	$T_a = 25^\circ\text{C}$, $C_L = 40\text{ pF}$, $V_O = 0.5V_{DD}$	–	20	–	ps
		SO3	$T_a = 25^\circ\text{C}$, $C_L = 25\text{ pF}$, $V_O = 0.5V_{DD}$	–	40	–	
		SO1, SO2	$T_a = 25^\circ\text{C}$, $C_L = 15\text{ pF}$, $V_O = 0.5V_{DD}$	–	40	–	
Output clock duty cycle ²	Dt	MO1	$T_a = 25^\circ\text{C}$, $C_L = 40\text{ pF}$, $V_O = 0.5V_{DD}$	45	50	55	%
		SO3	$T_a = 25^\circ\text{C}$, $C_L = 25\text{ pF}$, $V_O = 0.5V_{DD}$	45	50	55	
		SO1, SO2	$T_a = 25^\circ\text{C}$, $C_L = 15\text{ pF}$, $V_O = 0.5V_{DD}$	45	50	55	
Power-up time ^{2, 4}	t_p	All outputs excluding XTO		–	1	5	ms

1. When using an external clock input, the XTI duty should be 50% with 3.3V clock signal amplitude level. The input signal voltage should not exceed the absolute maximum rating, otherwise damage may occur.
2. The numeric values are measured values obtained using the circuit in Figure 1 and the NPC standard evaluation board.
3. The numeric values are measured values obtained using the circuit in Figure 2 and the NPC standard evaluation board.
4. This is the time, after the supply is turned ON from the OFF state, until the output clock reaches $\pm 0.1\%$ of the specified frequency.

SM8707 series

SM8707H

$f_{XTAL} = 27.0000\text{MHz}$, $V_{DD} = 3.3\text{V} \pm 0.3\text{V}$, $V_{SS} = 0\text{V}$, $T_a = -40$ to $+85$ °C unless otherwise noted.

Parameter	Symbol	Pins	Condition	Rating			Unit
				min	typ	max	
External input clock frequency ¹	f_{XTI}	XTI	Applies to external clock input use only	–	27.0000	–	MHz
Output clock rise time ²	t_r	MO1, MO2, SO2, SO3	$C_L = 25$ pF, transition between $V_{OL} = 0.2V_{DD}$ and $V_{OH} = 0.8V_{DD}$	–	2.0	–	ns
		SO1, AO1	$C_L = 15$ pF, transition between $V_{OL} = 0.2V_{DD}$ and $V_{OH} = 0.8V_{DD}$	–	2.0	–	
Output clock fall time ²	t_f	MO1, MO2, SO2, SO3	$C_L = 25$ pF, transition between $V_{OH} = 0.8V_{DD}$ and $V_{OL} = 0.2V_{DD}$	–	2.0	–	ns
		SO1, AO1	$C_L = 15$ pF, transition between $V_{OH} = 0.8V_{DD}$ and $V_{OL} = 0.2V_{DD}$	–	2.0	–	
Output clock jitter ³	t_{jitter} (1-sigma)	MO1, MO2	$T_a = 25^\circ\text{C}$, $C_L = 25$ pF, $V_O = 0.5V_{DD}$	–	20	–	ps
		SO2, SO3		–	70	–	
		SO1, AO1	$T_a = 25^\circ\text{C}$, $C_L = 15$ pF, $V_O = 0.5V_{DD}$	–	70	–	
Output clock duty cycle ²	Dt	MO1, MO2, SO2, SO3	$T_a = 25^\circ\text{C}$, $C_L = 25$ pF, $V_O = 0.5V_{DD}$	45	50	55	%
		SO1, AO1	$T_a = 25^\circ\text{C}$, $C_L = 15$ pF, $V_O = 0.5V_{DD}$	45	50	55	
Settling time ²	t_s	All outputs excluding XTO		–	–	1	μs
Power-up time ^{2, 4}	t_p	All outputs excluding XTO		–	1	5	ms

1. When using an external clock input, the XTI duty should be 50% with 3.3V clock signal amplitude level. The input signal voltage should not exceed the absolute maximum rating, otherwise damage may occur.
2. The numeric values are measured values obtained using the circuit in Figure 1 and the NPC standard evaluation board.
3. The numeric values are measured values obtained using the circuit in Figure 2 and the NPC standard evaluation board.
4. This is the time, after the supply is turned ON from the OFF state, until the output clock reaches $\pm 0.1\%$ of the specified frequency.

SM8707 series

SM8707J

$f_{XTAL} = 27.0000\text{MHz}$, $V_{DD} = 3.3\text{V} \pm 0.3\text{V}$, $V_{SS} = 0\text{V}$, $T_a = -40$ to $+85$ °C unless otherwise noted.

Parameter	Symbol	Pins	Condition	Rating			Unit
				min	typ	max	
External input clock frequency ¹	f_{XTI}	XTI	Applies to external clock input use only	-	27.0000	-	MHz
Frequency deviation ¹	D_f	SO1, SO2, SO3, SO4, AO1	Applies to external clock input use only, When frequency deviation of master clock is 0ppm	-15	-	+15	ppm
Output clock rise time ²	t_r	SO1, SO2, SO3, SO4, AO1	$C_L = 25\text{pF}$, transition between $V_{OL} = 0.2V_{DD}$ and $V_{OH} = 0.8V_{DD}$	-	2.0	-	ns
Output clock fall time ²	t_f	SO1, SO2, SO3, SO4, AO1	$C_L = 25\text{pF}$, transition between $V_{OH} = 0.8V_{DD}$ and $V_{OL} = 0.2V_{DD}$	-	2.0	-	ns
Output clock jitter ³	t_{jitter} (1-sigma)	SO1, SO2, SO3, SO4, AO1	$T_a = 25^\circ\text{C}$, $C_L = 25\text{pF}$, $V_O = 0.5V_{DD}$	-	60	-	ps
Output clock duty cycle ²	D_t	SO1, SO2, SO3, SO4, AO1	$T_a = 25^\circ\text{C}$, $C_L = 25\text{pF}$, $V_O = 0.5V_{DD}$	45	50	55	%
Settling time ²	t_s	All outputs excluding XTO		-	-	1	μs
Power-up time ^{2, 4}	t_p	All outputs excluding XTO		-	1	5	ms

1. When using an external clock input, the XTI duty should be 50% with 3.3V clock signal amplitude level. The input signal voltage should not exceed the absolute maximum rating, otherwise damage may occur.
2. The numeric values are measured values obtained using the circuit in Figure 1 and the NPC standard evaluation board.
3. The numeric values are measured values obtained using the circuit in Figure 2 and the NPC standard evaluation board.
4. This is the time, after the supply is turned ON from the OFF state, until the output clock reaches $\pm 0.1\%$ of the specified frequency.

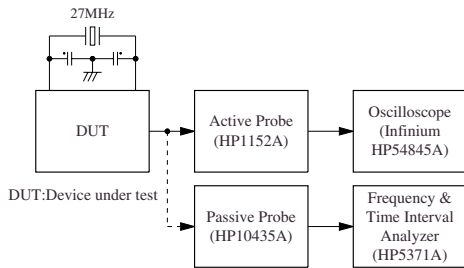

Figure 1. Measurement circuit 1

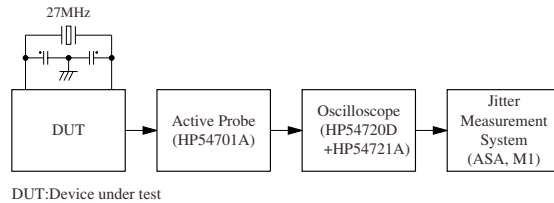

Figure 2. Measurement circuit 2

FUNCTIONAL DESCRIPTION

27MHz Master Clock

The SM8707 series 27MHz master clock circuit is configured, as shown in Figure 3 and 4, with the crystal oscillator element connected between XTI (pin 7) and XTO (pin 8).

Alternatively, the 27MHz master clock can be supplied from an external master clock input on XTI, as shown in Figure 5 and 6.

If an external input clock on XTI is used, it is recommended that the frequency be 27.0000MHz, with 50% duty, and 3.3V voltage amplitude level.

Furthermore, when using an external clock input, the input signal voltage should not exceed the absolute maximum rating, otherwise damage may occur.

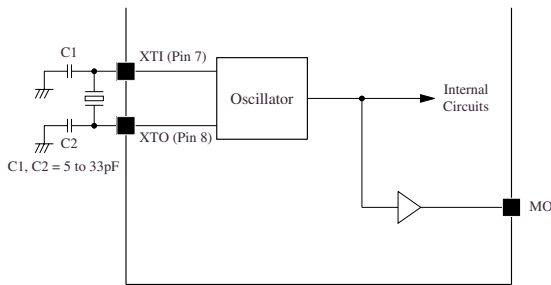

Figure 3. Crystal oscillator connection (excluding SM8707J)

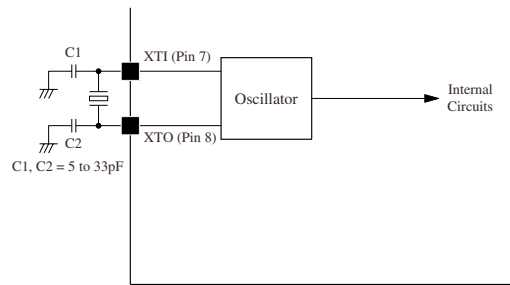

Figure 4. Crystal oscillator connection (SM8707J)

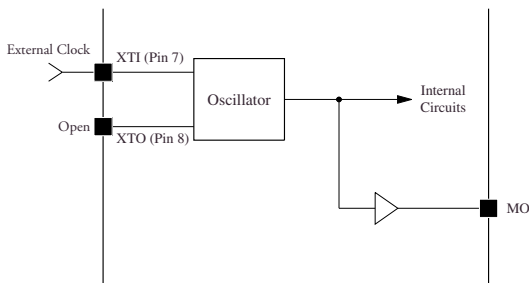

Figure 5. External clock input (excluding SM8707J)

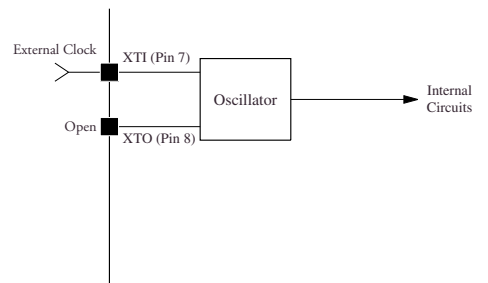

Figure 6. External clock input (SM8707J)

Sampling Frequency and Output Clock Frequency

SM8707D

The SM8707D sampling frequency f_s can be switched between 44.1kHz when FSEL (pin 14) is HIGH, and 48kHz when FSEL is LOW. The audio output (AO1) is a 384fs frequency clock when FSEL is HIGH ($f_s = 44.1\text{kHz}$), and 768fs frequency clock when FSEL is LOW ($f_s = 48\text{kHz}$) where f_s is determined by the setting on FSEL. The audio output (AO2) is a 512fs frequency clock. In addition, the signal processor output (SO1 and SO2) is a 16.9344MHz, 33.8688MHz frequency clock derived from the master clock. And the video output (MO1 and MO2) is a 27MHz frequency clock, identical to the master clock.

The SM8707D possible output clock frequencies are shown in Table 1.

Table 1. Sampling frequency and output clock frequency (27.0000MHz master clock frequency)

FSEL (Pin 14)	Sampling frequency f_s [kHz]	Output clock frequency [MHz]					
		AO1 (Pin 9)	AO2 (Pin 10)	SO1 (Pin 13)	SO2 (Pin 15)	MO1 (Pin 3)	MO2 (Pin 4)
HIGH	44.1	16.9344 (384fs)	22.5792 (512fs)	16.9344	33.8688	27.0000	27.0000
LOW	48	36.8640 (768fs)	24.5760 (512fs)	16.9344	33.8688	27.0000	27.0000

SM8707E

The SM8707E sampling frequency f_s can be switched between 44.1kHz when FSEL (pin 14) is LOW, and 48kHz when FSEL is HIGH. The audio output (AO1 and AO2) is a 512fs frequency clock, where f_s is determined by the setting on FSEL. In addition, the signal processor output (SO1 and SO2) is a 33.8688MHz frequency clock derived from the master clock. And the video output (MO1 and MO2) is a 27MHz frequency clock, identical to the master clock.

The SM8707E possible output clock frequencies are shown in Table 2.

Table 2. Sampling frequency and output clock frequency (27.0000MHz master clock frequency)

FSEL (Pin 14)	Sampling frequency f_s [kHz]	Output clock frequency [MHz]					
		AO1 (Pin 9)	AO2 (Pin 10)	SO1 (Pin 13)	SO2 (Pin 15)	MO1 (Pin 3)	MO2 (Pin 4)
HIGH	48	24.5760 (512fs)	24.5760 (512fs)	33.8688	33.8688	27.0000	27.0000
LOW	44.1	22.5792 (512fs)	22.5792 (512fs)	33.8688	33.8688	27.0000	27.0000

SM8707F

The SM8707F sampling frequency f_s can be switched between 44.1kHz when FSEL (pin 14) is HIGH, and 48kHz when FSEL is LOW. The audio outputs (AO1 and AO2) are equivalent to $768f_s$, where f_s is determined by the setting on FSEL. In addition, the signal processor outputs (SO1 and SO2) are 16.9344MHz and 33.8688MHz clocks, respectively, derived from the master clock. The video output (MO1) is a 27MHz clock, identical to the master clock.

The SM8707F supported clock frequencies are shown in Table 3.

Table 3. Sampling frequency and output clock frequency (27.0000MHz master clock frequency)

FSEL (Pin 14)	Sampling frequency f_s [kHz]	Output clock frequency [MHz]				
		AO1 (Pin 9)	AO2 (Pin 10)	SO1 (Pin 13)	SO2 (Pin 15)	MO1 (Pin 3)
HIGH	44.1	33.8688 (768 f_s)	33.8688 (768 f_s)	16.9344	33.8688	27.0000
LOW	48	36.8640 (768 f_s)	36.8640 (768 f_s)	16.9344	33.8688	27.0000

SM8707G

The SM8707G signal processor outputs (SO1, SO2 and SO3) are all 33.8688MHz clocks, derived from the master clock. The video output (MO1) is a 27MHz clock, identical to the master clock.

The SM8707G supported clock frequencies are shown in Table 4.

Table 4. Sampling frequency and output clock frequency (27.0000MHz master clock frequency)

Output clock frequency [MHz]			
SO1 (Pin 9)	SO2 (Pin 10)	SO3 (Pin 13)	MO1 (Pin 3)
33.8688	33.8688	33.8688	27.0000

SM8707H

The SM8707H sampling frequency f_s can be switched between 44.1kHz when FSEL (pin 14) is HIGH, and 48kHz when FSEL is LOW. The audio output (AO1) is equivalent to $512f_s$, where f_s is determined by the setting on FSEL. In addition, the signal processor outputs (SO1, SO2 and SO3) are 36.8640MHz, 16.9344MHz and 33.8688MHz clocks, respectively, derived from the master clock. The video outputs (MO1 and MO2) are 27MHz clocks, identical to the master clock.

The SM8707H supported clock frequencies are shown in Table 5.

Table 5. Sampling frequency and output clock frequency (27.0000MHz master clock frequency)

FSEL (Pin 14)	Sampling frequency f_s [kHz]	Output clock frequency [MHz]					
		AO1 (Pin 10)	SO1 (Pin 9)	SO2 (Pin 13)	SO3 (Pin 15)	MO1 (Pin 3)	MO2 (Pin 4)
HIGH	44.1	22.5792 (512 f_s)	36.8640	16.9344	33.8688	27.0000	27.0000
LOW	48	24.5760 (512 f_s)	36.8640	16.9344	33.8688	27.0000	27.0000

SM8707J

The SM8707J sampling frequency f_s can be switched between 44.1kHz when FSEL (pin 14) is HIGH, and 48kHz when FSEL is LOW. The audio output (AO1) is equivalent to $768f_s$, where f_s is determined by the setting on FSEL. In addition, the signal processor outputs (SO1, SO2, SO3 and SO4) are 24.5760MHz, 18.4320MHz, 36.8640MHz and 33.8688MHz clocks, respectively, derived from the master clock.

The SM8707J supported clock frequencies are shown in Table 6.

Table 6. Sampling frequency and output clock frequency (27.0000MHz master clock frequency)

FSEL (Pin 14)	Sampling frequency f_s [kHz]	Output clock frequency [MHz]				
		AO1 (Pin 10)	SO1 (Pin 4)	SO2 (Pin 9)	SO3 (Pin 13)	SO4 (Pin 15)
HIGH	44.1	33.8688 (768 f_s)	24.5760	18.4320	36.8640	33.8688
LOW	48	36.8640 (768 f_s)	24.5760	18.4320	36.8640	33.8688

Spike Noise Prevention Function

All device versions, excluding the SM8707G which has no FSEL input, have a spike noise prevention circuit that prevents any spike noise generation in the audio output clocks when the sampling frequency is switched using FSEL.

The state of the AO× output before and after FSEL is switched is shown in Figure 7.

When FSEL is switched, either from LOW to HIGH or HIGH to LOW, the spike noise prevention circuit stops the AO× clock output by a maximum of 1μs, and then the output clock changes to reflect the current FSEL setting.

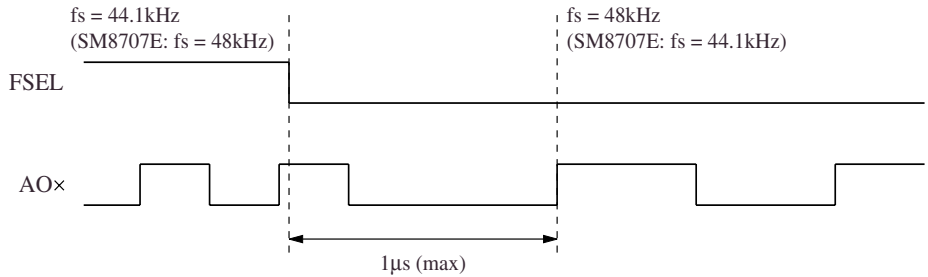

Figure 7. Spike noise prevention circuit timing at sampling frequency switching

Sampling Frequency Switching Settling Time

The clock output response when the sampling frequency is switched using FSEL is shown in Figure 8. Note that all device versions, excluding the SM8707G which has no FSEL input, have a spike noise prevention circuit which stops the output AO× clocks for a fixed interval, which means the settling time is a maximum 1μs when the sampling frequency is switched.

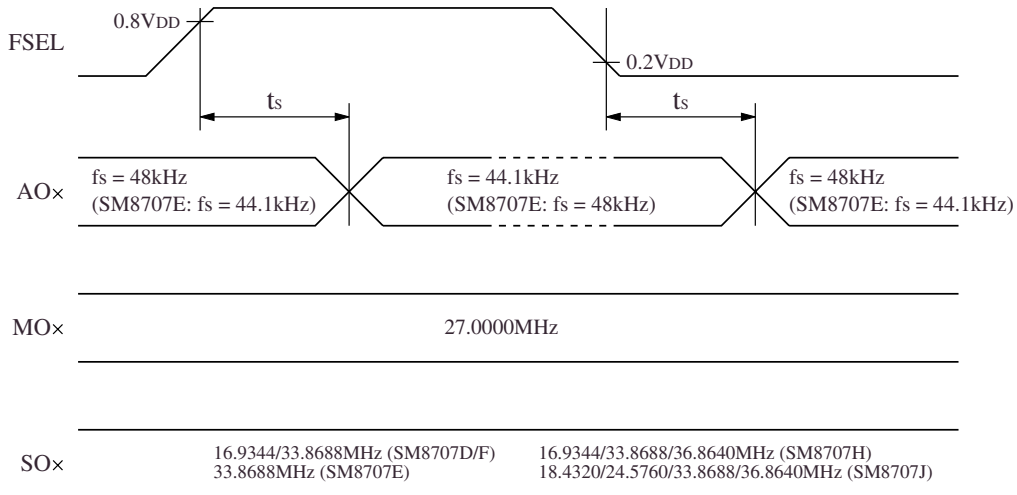

Figure 8. Output signal switching timing

SM8707 series

SM8707 series OUTPUT FREQUENCY LISTING

Version	FSEL polarity (Pin 14)	Sampling frequency fs [kHz]	Output clock frequency [MHz]					
			Pin 3	Pin 4	Pin 9	Pin 10	Pin 13	Pin 15
SM8707D	H	44.1	27.0000	27.0000	16.9344 (384fs)	22.5792 (512fs)	16.9344	33.8688
	L	48.0	27.0000	27.0000	36.8640 (768fs)	24.5760 (512fs)	16.9344	33.8688
	Output load capacitance [pF]		25	25	15	15	25	25
	Pin name		MO1	MO2	AO1	AO2	SO1	SO2
SM8707E	H	48.0	27.0000	27.0000	24.5760 (512fs)	24.5760 (512fs)	33.8688	33.8688
	L	44.1	27.0000	27.0000	22.5792 (512fs)	22.5792 (512fs)	33.8688	33.8688
	Output load capacitance [pF]		40	25	15	15	15	15
	Pin name		MO1	MO2	AO1	AO2	SO1	SO2
SM8707F	H	44.1	27.0000	-	33.8688 (768fs)	33.8688 (768fs)	16.9344	33.8688
	L	48.0	27.0000		36.8640 (768fs)	36.8640 (768fs)	16.9344	33.8688
	Output load capacitance [pF]		25	-	15	15	25	25
	Pin name		MO1	NC1	AO1	AO2	SO1	SO2
SM8707G	-	-	27.0000	-	33.8688	33.8688	33.8688	-
	Output load capacitance [pF]		40	-	15	15	25	-
	Pin name		MO1	NC1	SO1	SO2	SO3	NC1
SM8707H	H	44.1	27.0000	27.0000	36.8640	22.5792 (512fs)	16.9344	33.8688
	L	48.0	27.0000	27.0000	36.8640	24.5760 (512fs)	16.9344	33.8688
	Output load capacitance [pF]		25	25	15	15	25	25
	Pin name		MO1	MO2	SO1	AO1	SO2	SO3
SM8707J	H	44.1	-	24.5760	18.4320	33.8688 (768fs)	36.8640	33.8688
	L	48.0		24.5760	18.4320	36.8640 (768fs)	36.8640	33.8688
	Output load capacitance [pF]		-	25	25	25	25	25
	Pin name		NC1	SO1	SO2	AO1	SO3	SO4

Please pay your attention to the following points at time of using the products shown in this document.

The products shown in this document (hereinafter "Products") are not intended to be used for the apparatus that exerts harmful influence on human lives due to the defects, failure or malfunction of the Products. Customer are requested to obtain prior written agreement for such use from NIPPON PRECISION CIRCUITS INC. (hereinafter "NPC"). Customers shall be solely responsible for, and indemnify and hold NPC free and harmless from, any and all claims, damages, losses, expenses or lawsuits, due to such use without such agreement. NPC reserves the right to change the specifications of the Products in order to improve the characteristic or reliability thereof. NPC makes no claim or warranty that the contents described in this document dose not infringe any intellectual property right or other similar right owned by third parties. Therefore, NPC shall not be responsible for such problems, even if the use is in accordance with the descriptions provided in this document. Any descriptions including applications, circuits, and the parameters of the Products in this documents are for reference to use the Products, and shall not be guaranteed free from defect, inapplicability to the design for the mass-production products without further testing or modification. Customers are requested not to export or re-export, directly or indirectly, the Products to any country or any entity not in compliance with or in violation of the national export administration laws, treaties, orders and regulations. Customers are requested appropriately take steps to obtain required permissions or approvals from appropriate government agencies.

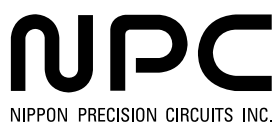

NIPPON PRECISION CIRCUITS INC.

4-3, Fukuzumi 2-chome, Koto-ku,
Tokyo 135-8430, Japan
Telephone: +81-3-3642-6661
Facsimile: +81-3-3642-6698
<http://www.npc.co.jp/>
Email: sales@npc.co.jp

NC0107BE 2002.08