

OVERVIEW

The WF5028 series are miniature crystal oscillator module ICs. The devices are fabricated using a proprietary low voltage process, enabling 0.8V operation. The pad layouts are selective from 3 types depending on package structures, mounting methods, which are suitable for miniature crystal oscillators. The WF5028 series can be used to realize ultra miniature, ultra low voltage crystal oscillators.

FEATURES

- Wide range of operating supply voltage: 0.8 to 2.0V
- Optimized low crystal drive current oscillation for miniature crystal units
- 3 pad layout options for mounting
 - WF5028A× series: for Flip Chip Bonding
 - CF5028B× series: for Wire Bonding (type I)
 - CF5028C× series: for Wire Bonding (type II)
- Recommended oscillation frequency range: 20MHz to 50MHz
- Multi-stage frequency divider for low-frequency output support: 0.75MHz (min)
- Frequency divider built-in
 - Selectable by version: f_O , $f_O/2$, $f_O/4$, $f_O/8$, $f_O/16$, $f_O/32$, $f_O/64$
- -40 to 85°C operating temperature range
- Standby function
 - High impedance in standby mode, oscillator stops
- CMOS output duty level (1/2VDD)
 - 50 ± 5% output duty
 - 15pF output drive capability
- Wafer form (WF5028××)
Chip form (CF5028××)

APPLICATIONS

- 3.2 × 2.5, 2.5 × 2.0, 2.0 × 1.6 size miniature crystal oscillator modules

ORDERING INFORMATION

Device	Package
WF5028××-4	Wafer form
CF5028××-4	Chip form

PAD LAYOUT

(Unit: μm)

■ WF5028A \times
(for Flip Chip Bonding)

■ CF5028B \times
(for Wire Bonding (type I))

■ CF5028C \times
(for Wire Bonding (type II))

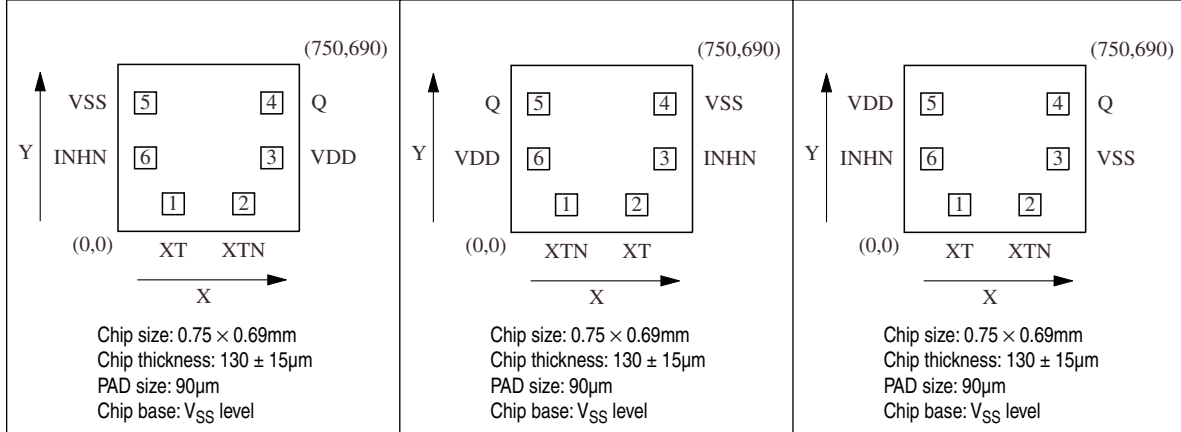

PAD DIMENSIONS PIN DESCRIPTION

Pad No.	Pad dimensions [μm]		Pad No.			Pin	Name	Description
	X	Y	5028A \times	5028B \times	5028C \times			
1	229	114	1	2	1	XT	Amplifier input	Crystal connection pins. Crystal is connected between XT and XTN.
2	520	114	2	1	2	XTN	Amplifier output	
3	636	304	3	6	5	VDD	(+) supply voltage	-
4	636	531	4	5	4	Q	Output	Output frequency determined by internal circuit to one of $f_O, f_O/2, f_O/4, f_O/8, f_O/16, f_O/32, f_O/64$
5	114	531	5	4	3	VSS	(-) ground	-
6	114	304	6	3	6	INHN	Output state control input	High impedance when LOW (oscillator stops). Power-saving pull-up resistor built-in.

BLOCK DIAGRAM

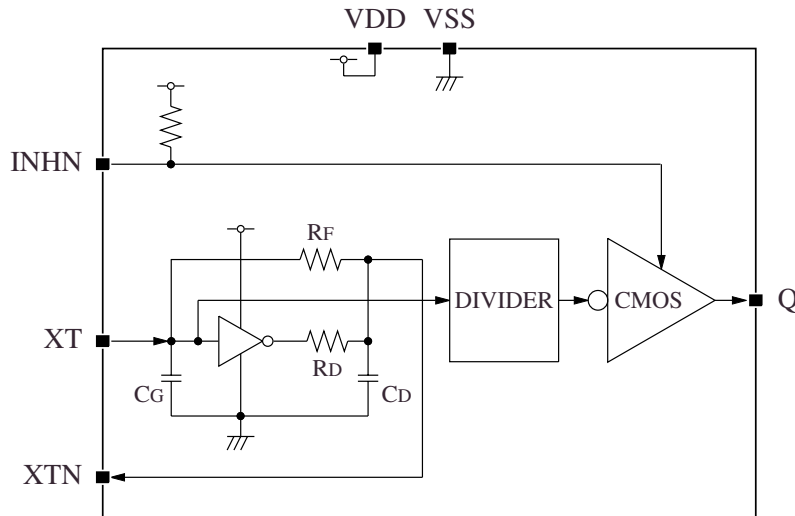

VERSION DISCRIMINATION INTERNAL COMPONENTS

The WF5028 series device version is not determined solely by the mask pattern, but can also be determined by the trimming of internal trimming fuses.

■ Version determined by laser trimming:

These chips are produced from a common device by the laser trimming of fuses corresponding to the ordered version, shown in table 1. These devices are shipped for electrical characteristics testing. Laser-trimmed versions are identified externally by the combination of the version name marking (1) and the locations of trimmed fuses (2).

■ Version determined by mask pattern:

These chips are fabricated using the mask corresponding to the ordered version, and do not require trimming. Mask-fabricated versions are identified externally by the version name marking (1) only.

Since the WF5028 series devices are manufactured using 2 methods, there are 2 types of IC chip available (identified externally) for the same version name. The identification markings for all WF5028 series device versions is shown in table 2.

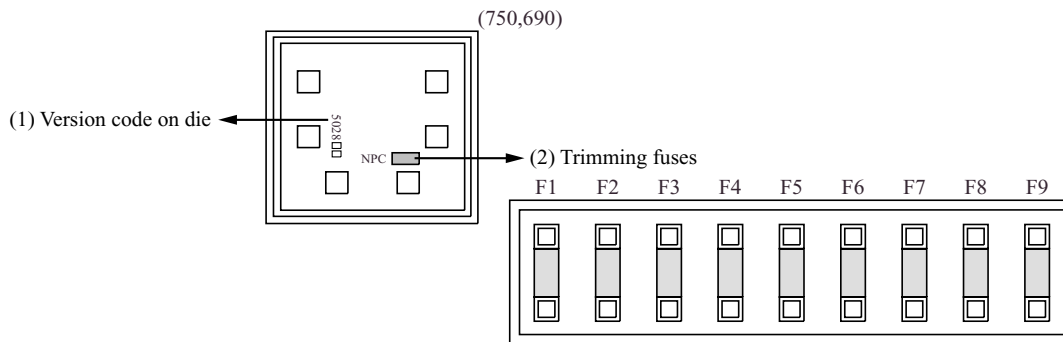
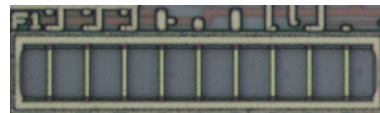

Table 1. Version and trimming fuses

Version	Trimming fuse number ^{*1}		
	F1	F2	F3
WF5028×1	-	-	-
WF5028×2	×	-	-
WF5028×3	-	×	-
WF5028×4	×	×	-
WF5028×5	-	-	×
WF5028×6	×	-	×
WF5028×7	-	×	×

*1. -: untrimmed, ×: trimmed, F4 to F9 not used

■ 5028×1 trimming fuses (untrimmed)



■ 5028×2 trimming fuses (F1 link trimmed)

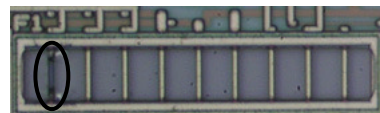

■ 5028×3 trimming fuses (F2 link trimmed)

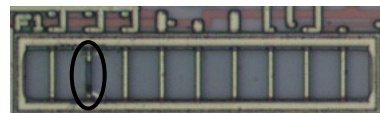

■ 5028×4 trimming fuses (F1 and F2 links trimmed)



○ : trimmed device

WF5028 series

Table 2. Version identification by version name and chip markings

Version name	Version set by trimming fuses										Version set by mask pattern	
	Version name chip marking	Trimming fuses ^{*1}									Version name chip marking	Trimming fuses F1 to F9
		F1	F2	F3	F4	F5	F6	F7	F8	F9		
5028A1	AX	–	–	–	Untrimmed						AX	Untrimmed
5028A2	AX	×	–	–							A2	
5028A3	AX	–	×	–							A3	
5028A4	AX	×	×	–							A4	
5028A5	AX	–	–	×							A5	
5028A6	AX	×	–	×							A6	
5028A7	AX	–	×	×							A7	
5028B1	BX	–	–	–							BX	
5028B2	BX	×	–	–							B2	
5028B3	BX	–	×	–							B3	
5028B4	BX	×	×	–							B4	
5028B5	BX	–	–	×							B5	
5028B6	BX	×	–	×							B6	
5028B7	BX	–	×	×							B7	
5028C1	CX	–	–	–							CX	
5028C2	CX	×	–	–							C2	
5028C3	CX	–	×	–							C3	
5028C4	CX	×	×	–							C4	
5028C5	CX	–	–	×							C5	
5028C6	CX	×	–	×							C6	
5028C7	CX	–	×	×							C7	

*1. –: untrimmed, ×: trimmed

SPECIFICATIONS

Absolute Maximum Ratings

 $V_{SS} = 0V$

Parameter	Symbol	Condition	Rating	Unit
Supply voltage range	V_{DD}	Between VDD and VSS	-0.5 to +4.0	V
Input voltage range	V_{IN}	Input pins	-0.5 to $V_{DD} + 0.5$	V
Output voltage range	V_{OUT}	Output pins	-0.5 to $V_{DD} + 0.5$	V
Storage temperature range	T_{STG}	Wafer form	-65 to +150	°C
Output current	I_{OUT}	Q pin	± 20	mA

Recommended Operating Conditions

 $V_{SS} = 0V$

Parameter	Symbol	Condition	Rating			Unit
			min	typ	max	
Operating supply voltage	V_{DD}	$C_L \leq 15pF$	0.8	-	2.0	V
Input voltage	V_{IN}	Input pins	V_{SS}	-	V_{DD}	V
Operating temperature	T_{OPR}		-40	-	+85	°C
Oscillation frequency ^{*1}	f_O	5028×1 to 5028×7	20	-	50	MHz
Output frequency	f_{OUT}	5028×1 to 5028×7, $C_L \leq 15pF$	0.75	-	50	MHz

*1. The oscillation frequency is a yardstick value derived from the crystal used for NPC characteristics authentication. However, the oscillation frequency range is not guaranteed. Specifically, the characteristics can vary greatly due to crystal characteristics and mounting conditions, so the oscillation characteristics of components must be carefully evaluated.

Electrical Characteristics

DC Characteristics

$V_{DD} = 0.8$ to $2.0V$, $V_{SS} = 0V$, $T_a = -40$ to $+85^{\circ}C$ unless otherwise noted.

Parameter	Symbol	Condition		Rating			Unit		
				min	typ	max			
HIGH-level output voltage	V_{OH}	Q: Measurement cct 3	$I_{OH} = -0.7mA, V_{DD} = 0.8V$	0.6	–	–	V		
			$I_{OH} = -3mA, V_{DD} = 1.1V$	0.8	–	–	V		
			$I_{OH} = -5mA, V_{DD} = 1.4V$	1.0	–	–	V		
LOW-level output voltage	V_{OL}	Q: Measurement cct 3	$I_{OL} = 0.7mA, V_{DD} = 0.8V$	–	–	0.2	V		
			$I_{OL} = 3mA, V_{DD} = 1.1V$	–	–	0.3	V		
			$I_{OL} = 5mA, V_{DD} = 1.4V$	–	–	0.4	V		
HIGH-level input voltage	V_{IH}	INH, Measurement cct 4		$0.7V_{DD}$	–	–	V		
LOW-level input voltage	V_{IL}	INH, Measurement cct 4		–	–	$0.3V_{DD}$	V		
Output leakage current	I_Z	Q: Measurement cct 5, INH = LOW, $T_a = 25^{\circ}C$	$V_{OH} = V_{DD}$	–	–	20	μA		
			$V_{OL} = V_{SS}$	20	–	–	μA		
Current consumption *1	I_{DD}	5028×1 (f_O), Measurement cct 1, no load, INH = open, $f_O = 48MHz$, $f_{OUT} = 48MHz$	$V_{DD} = 1.5V$	–	1.7	2.6	mA		
			$V_{DD} = 1.2V$	–	1.3	2.0	mA		
			$V_{DD} = 0.9V$	–	0.9	1.4	mA		
			5028×2 ($f_O/2$), Measurement cct 1, no load, INH = open, $f_O = 48MHz$, $f_{OUT} = 24MHz$	$V_{DD} = 1.5V$	–	1.5	2.3	mA	
				$V_{DD} = 1.2V$	–	1.1	1.7	mA	
				$V_{DD} = 0.9V$	–	0.8	1.2	mA	
			5028×3 ($f_O/4$), Measurement cct 1, no load, INH = open, $f_O = 48MHz$, $f_{OUT} = 12MHz$	$V_{DD} = 1.5V$	–	1.3	2.0	mA	
				$V_{DD} = 1.2V$	–	1.0	1.5	mA	
				$V_{DD} = 0.9V$	–	0.6	0.9	mA	
		5028×4 ($f_O/8$), Measurement cct 1, no load, INH = open, $f_O = 48MHz$, $f_{OUT} = 6MHz$	$V_{DD} = 1.5V$	–	1.2	1.8	mA		
			$V_{DD} = 1.2V$	–	0.9	1.4	mA		
			$V_{DD} = 0.9V$	–	0.55	0.9	mA		
		5028×5 ($f_O/16$), Measurement cct 1, no load, INH = open, $f_O = 48MHz$, $f_{OUT} = 3MHz$	$V_{DD} = 1.5V$	–	1.1	1.7	mA		
			$V_{DD} = 1.2V$	–	0.8	1.2	mA		
			$V_{DD} = 0.9V$	–	0.5	0.8	mA		
		5028×6 ($f_O/32$), Measurement cct 1, no load, INH = open, $f_O = 48MHz$, $f_{OUT} = 1.5MHz$	$V_{DD} = 1.5V$	–	1.1	1.7	mA		
			$V_{DD} = 1.2V$	–	0.8	1.2	mA		
			$V_{DD} = 0.9V$	–	0.5	0.8	mA		
		5028×7 ($f_O/64$), Measurement cct 1, no load, INH = open, $f_O = 48MHz$, $f_{OUT} = 0.75MHz$	$V_{DD} = 1.5V$	–	1.1	1.7	mA		
			$V_{DD} = 1.2V$	–	0.8	1.2	mA		
			$V_{DD} = 0.9V$	–	0.5	0.8	mA		
		Standby current	I_{ST}	Measurement cct 1, INH = LOW, $T_a = 25^{\circ}C$		–	–	100	μA
		INH pull-up resistance	R_{UP1}	Measurement cct 6		0.4	2	10	$M\Omega$
			R_{UP2}			30	70	150	$k\Omega$
Oscillator feedback resistance	R_f			50	100	200	$k\Omega$		
Oscillator capacitance	C_G	Design value (a monitor pattern on a wafer is tested), Excluding parasitic capacitance.		–	2	–	pF		
	C_D			–	12	–	pF		

*1. When loading the capacitance to Q pin, the charge and discharge current (I_{CL}) consumed by load capacitance (C_L) is given by the following equation.

(output frequency: f_{OUT})

$$I_{CL} = C_L \times V_{DD} \times f_{OUT}$$

AC Characteristics

$V_{DD} = 0.8$ to $2.0V$, $V_{SS} = 0V$, $T_a = -40$ to $+85^{\circ}C$ unless otherwise noted.

Parameter	Symbol	Condition	Rating			Unit	
			min	typ	max		
Output rise time	t_{r1}	Measurement cct 1, $C_L = 15pF$, $0.2V_{DD}$ to $0.8V_{DD}$	$V_{DD} = 1.1$ to $2.0V$	-	1.3	3.0	ns
	t_{r2}		$V_{DD} = 0.8$ to $1.1V$	-	1.7	4.0	ns
Output fall time	t_{f1}	Measurement cct 1, $C_L = 15pF$, $0.8V_{DD}$ to $0.2V_{DD}$	$V_{DD} = 1.1$ to $2.0V$	-	1.3	3.0	ns
	t_{f2}		$V_{DD} = 0.8$ to $1.1V$	-	1.7	4.0	ns
Output duty cycle	Duty	Measurement cct 1, $T_a = 25^{\circ}C$, $C_L = 15pF$	45	50	55	%	
Output disable delay time	t_{OD}	Measurement cct 2, $T_a = 25^{\circ}C$, $C_L \leq 15pF$	-	-	50	μs	

Timing chart

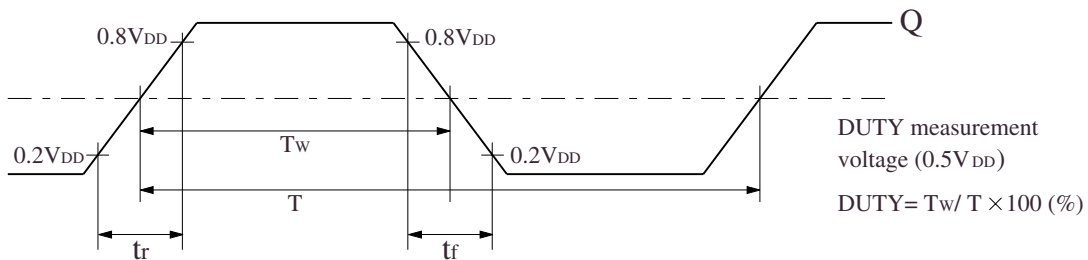
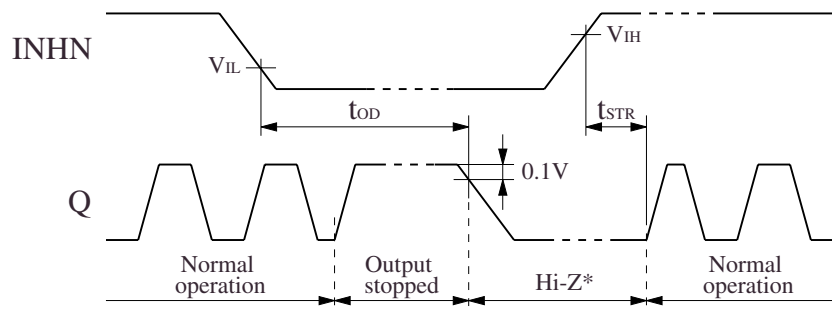

Figure 1. Output switching waveform



When INHN goes HIGH to LOW, the Q output goes HIGH once and then becomes high impedance.

When INHN goes LOW to HIGH, the Q output goes from high impedance to normal output operation when the oscillation starts (oscillation is detected).

*) The high-impedance interval in the figure is shown as a LOW level due to the $1k\Omega$ pull-down resistor connected to the Q pin (see "Measurement circuit 2" in the "Measurement Circuits" section).

Figure 2. Output disable and oscillation start timing chart

FUNCTIONAL DESCRIPTION

Standby Function

When INHN goes LOW, the Q output becomes high impedance.

INHN	Q	Oscillator
HIGH (or open)	Frequency output	Normal operation
LOW	High impedance	Stopped

Power-saving Pull-up Resistor

The INHN pin pull-up resistance R_{UP1} or R_{UP2} changes in response to the input level (HIGH or LOW). When INHN is tied LOW level, the pull-up resistance is large (R_{UP1}), reducing the current consumed by the resistance. When INHN is left open circuit, the pull-up resistance is small (R_{UP2}), which increases the input susceptibility to external noise. However, the pull-up resistance ties the INHN pin HIGH level to prevent external noise from unexpectedly stopping the output.

Oscillation Detector Function

The WF5028 series also feature an oscillation detector circuit. This circuit functions to disable the outputs until the oscillator circuit starts and oscillation becomes stable. This alleviates the danger of abnormal oscillator output at oscillator start-up when power is applied or when INHN is switched.

MEASUREMENT CIRCUITS

Measurement cct 1

Measurement parameter: I_{DD} , I_{ST} , Duty, t_r , t_f

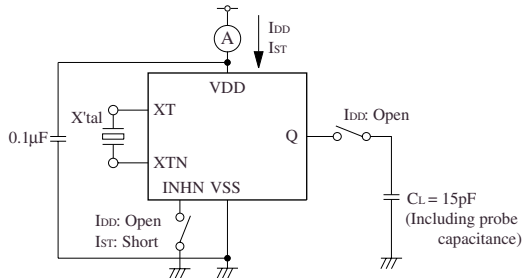

Note: The AC characteristics are observed using an oscilloscope on pin Q.

Measurement cct 4

Measurement parameter: V_{IH} , V_{IL}

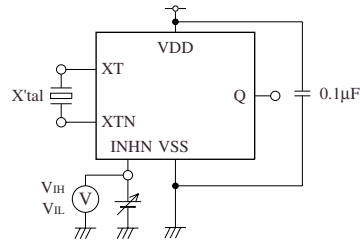

V_{IH} : Voltage in V_{SS} to V_{DD} transition that changes the output state.
 V_{IL} : Voltage in V_{DD} to V_{SS} transition that changes the output state.
 INHN has an oscillation stop function.

Measurement cct 2

Measurement parameter: t_{OD}

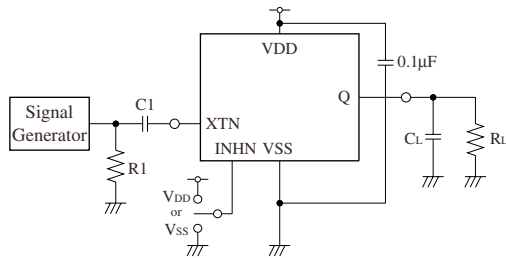

XTN input signal: 1Vp-p, sine wave
 $C1: 0.001\mu F$ $C_L: 15pF$
 $R1: 50\Omega$ $R_L: 1k\Omega$

Measurement cct 5

Measurement parameter: I_Z

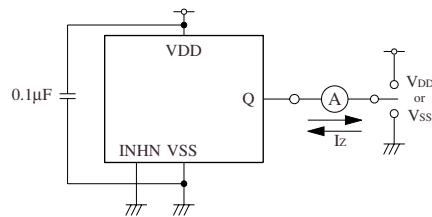

Measurement cct 6

Measurement parameter: R_{UP1} , R_{UP2}

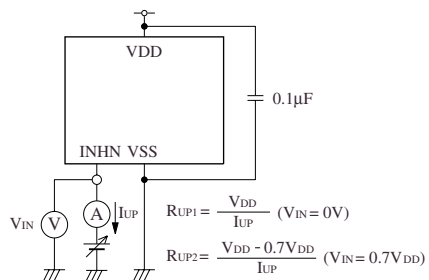

Measurement cct 3

Measurement parameter: V_{OH} , V_{OL}

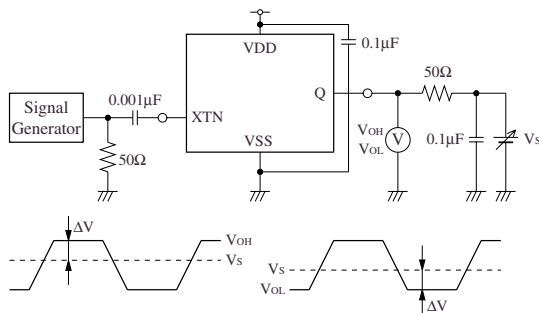

V_S adjusted such that $\Delta V = 50 \times I_{OH}$. V_S adjusted such that $\Delta V = 50 \times I_{OL}$.

XTN input signal: 1Vp-p, sine wave

TYPICAL PERFORMANCE

The following characteristics measured using the crystal below. Note that the characteristics will vary with the crystal used.

■ Crystal used for measurement

Parameter	$f_0 = 48\text{MHz}$
C_0 [pF]	1.6
R_1 [Ω]	12

■ Crystal parameters

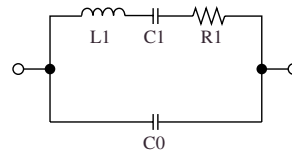

Current Consumption

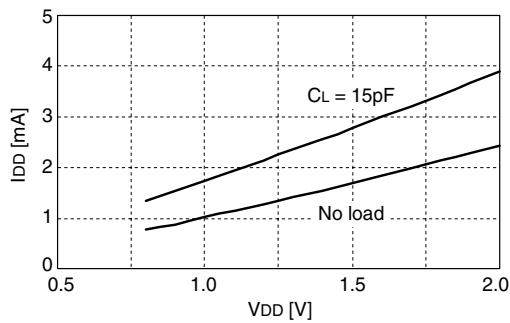

5028×1, $f_{OSC} = 48\text{MHz}$, $f_{OUT} = 48\text{MHz}$, $T_a = 25^\circ\text{C}$

Negative Resistance

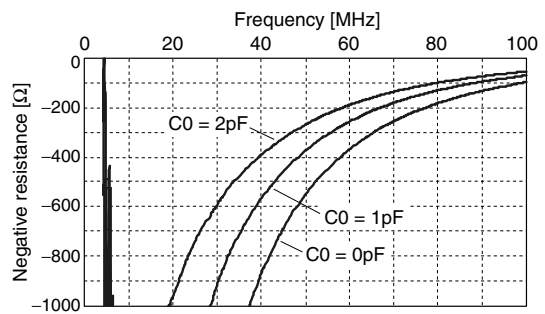

5028×1, $V_{DD} = 0.9\text{V}$, $T_a = 25^\circ\text{C}$

Characteristics are measured with a capacitance C_0 , representing the crystal equivalent circuit C_0 capacitance, connected between the XT and XTN pins. Measurements are performed with Agilent 4396B using the NPC test jig. Characteristics may vary with measurement jig and measurement conditions.

Frequency Deviation by Supply Voltage Change

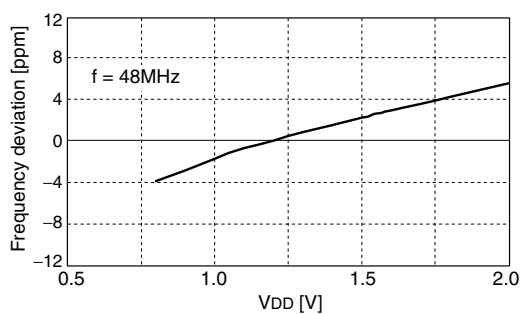

5028×1, $C_L = 15\text{pF}$, 1.2V standard, $T_a = 25^\circ\text{C}$

Drive Level

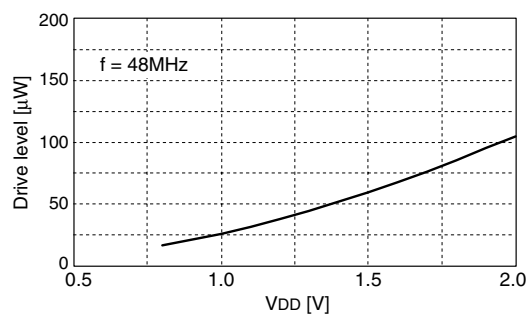

5028×1, $f_{OSC} = 48\text{MHz}$, $T_a = 25^\circ\text{C}$

Phase Noise

Measurement equipment: Agilent E5052
Signal Source Analyzer

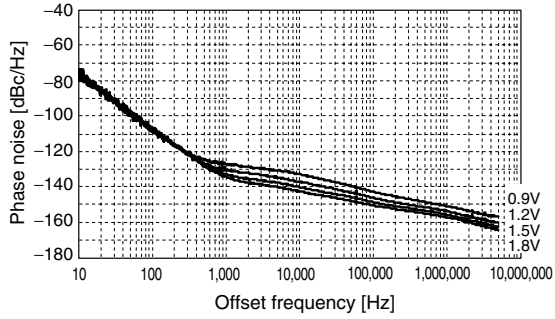

5028×1, $f_{OSC} = 48\text{MHz}$, $f_{OUT} = 48\text{MHz}$, $T_a = 25^\circ\text{C}$

Output Waveform

Measurement equipment: Agilent DSO80604B
Oscilloscope

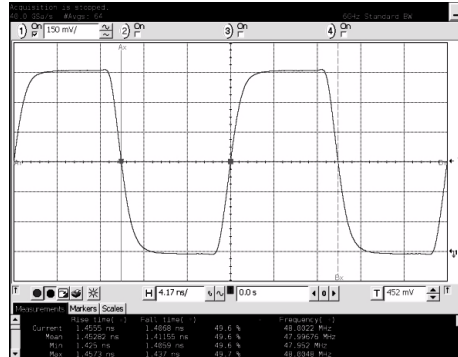

5028×1, $V_{DD} = 0.9\text{V}$, $f_{OUT} = 48\text{MHz}$,
 $C_L = 15\text{pF}$, $T_a = \text{RT}$

Please pay your attention to the following points at time of using the products shown in this document.

The products shown in this document (hereinafter "Products") are not intended to be used for the apparatus that exerts harmful influence on human lives due to the defects, failure or malfunction of the Products. Customers are requested to obtain prior written agreement for such use from SEIKO NPC CORPORATION (hereinafter "NPC"). Customers shall be solely responsible for, and indemnify and hold NPC free and harmless from, any and all claims, damages, losses, expenses or lawsuits, due to such use without such agreement. NPC reserves the right to change the specifications of the Products in order to improve the characteristic or reliability thereof. NPC makes no claim or warranty that the contents described in this document dose not infringe any intellectual property right or other similar right owned by third parties. Therefore, NPC shall not be responsible for such problems, even if the use is in accordance with the descriptions provided in this document. Any descriptions including applications, circuits, and the parameters of the Products in this document are for reference to use the Products, and shall not be guaranteed free from defect, inapplicability to the design for the mass-production products without further testing or modification. Customers are requested not to export or re-export, directly or indirectly, the Products to any country or any entity not in compliance with or in violation of the national export administration laws, treaties, orders and regulations. Customers are requested appropriately take steps to obtain required permissions or approvals from appropriate government agencies.

The logo for SEIKO NPC CORPORATION, consisting of the letters 'NPC' in a bold, black, sans-serif font.

SEIKO NPC CORPORATION

15-6, Nihombashi-kabutocho, Chuo-ku,
Tokyo 103-0026, Japan
Telephone: +81-3-6667-6601
Facsimile: +81-3-6667-6611
<http://www.npc.co.jp/>
Email: sales@npc.co.jp

NC0606AE 2008.01